

Schottky Barrier Diode

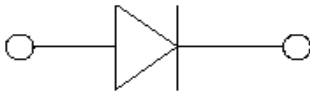

Features

- For Power Supply
- Moisture Sensitivity Level 1
- Low Voltage, Low Inductance

Mechanical Data

- **Package:** SOD-323
- **Terminals:** Tin plated leads, solderable per J-STD-002 and JESD22-B102
- **Polarity:** Cathode line denotes the cathode end
- **Marking:** D4

■ Maximum Ratings (Ta=25°C Unless otherwise specified)

PARAMETER	SYMBOL	UNIT	Conditions	VALUE
DC Blocking Voltage	V_R	V		40
Non-repetitive Peak forward surge current	I_{FSM}	A		2
Average forward current	I_{FAV}	A		0.5
Power Dissipation	P_D	mW		200
Thermal Resisance Junction to Ambient Air	$R_{\theta JA}$	°C/W		500
Junction temperature	T_j	°C		125
Storage temperature range	T_{stg}	°C		-55 to +150

*Part mounted on FR-4 board with recommended pad layout.

■ Ordering Information (Example)

PREFERRED P/N	PACKING CODE	UNIT WEIGHT(g)	MINIMUM PACKAGE(pcs)	INNER BOX QUANTITY(pcs)	OUTER CARTON QUANTITY(pcs)	DELIVERY MODE
RB551V-40	F2	Approximate 0.0048	3000	30000	120000	7" reel



RB551V-40

■ Electrical Characteristics (T_a=25°C Unless otherwise specified)

PARAMETER	Symbol	UNIT	Conditions	Min.	Typ.	Max.
Forward Voltage *	V _F	V	I _F =0.5A	-	-	0.47
Reverse Voltage	V _R	V	I _R =0.1mA	40		
Reverse Leakage Current	I _R	μA	V _R =40V	-	-	100

■ Typical Characteristics

Fig. 1 - Forward Characteristics

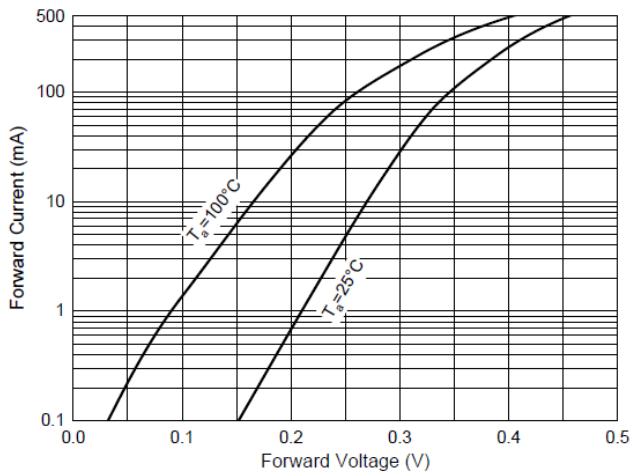

Fig. 2 - Reverse Characteristics

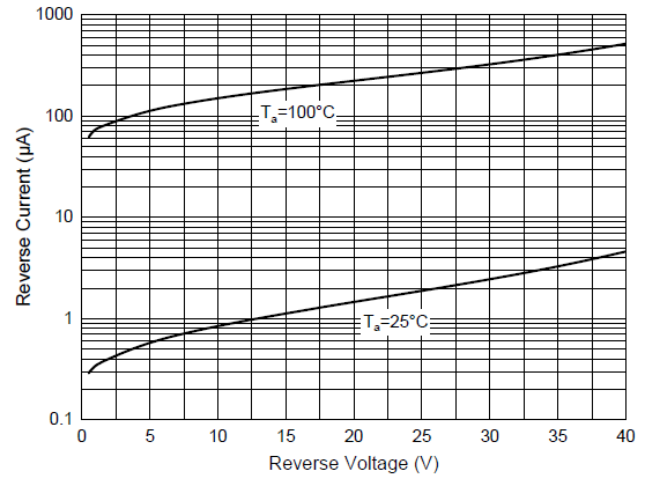

Fig. 3 - Capacitance Characteristics

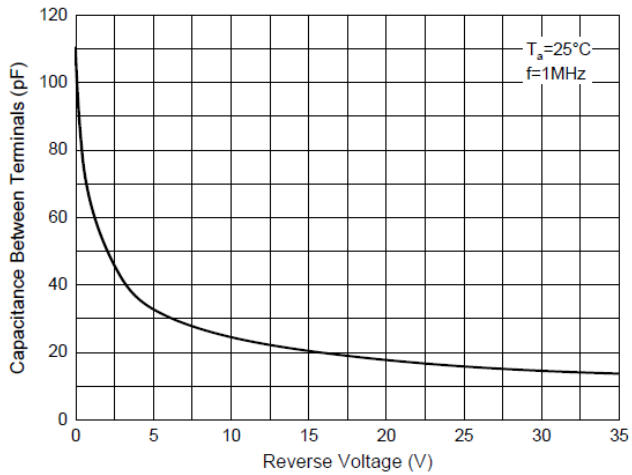
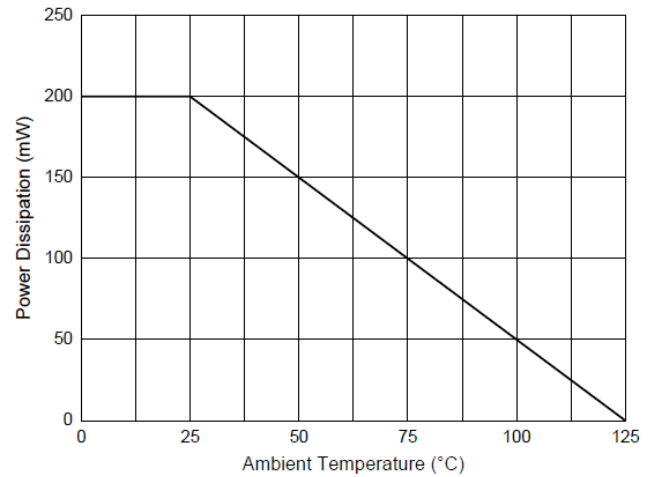

Fig. 4 - Power Derating Curve





RB551V-40

■ Outline Dimensions

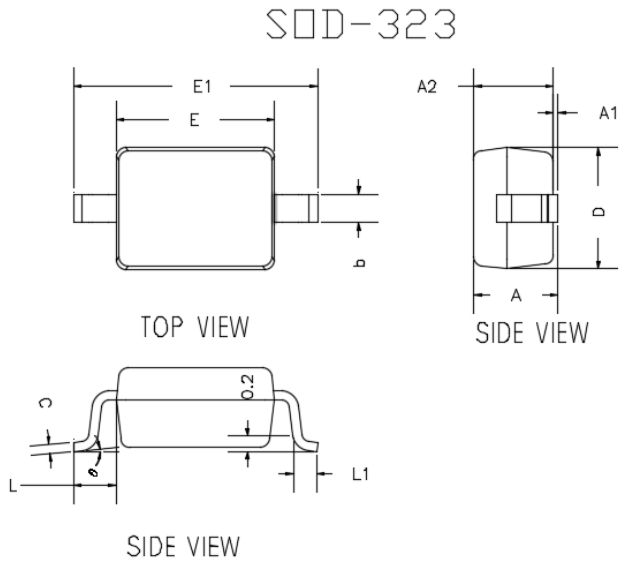

DIMENSIONS				
DIM	INCHES		MM	
	MIN	MAX	MIN	MAX
A	---	0.0393	---	1.0000
A1	0.0000	0.0039	0.0000	0.1000
A2	0.0314	0.0354	0.8000	0.9000
b	0.0098	0.0157	0.2500	0.4000
c	0.0031	0.0059	0.0800	0.1500
D	0.0472	0.0551	1.2000	1.4000
E	0.0629	0.0709	1.6000	1.8000
E1	0.0984	0.1063	2.5000	2.7000
L	0.0187TYP		0.475TYP	
L1	0.0098	0.0157	0.250	0.400
e	0°	8°	0°	8°

■ Soldering Footprint

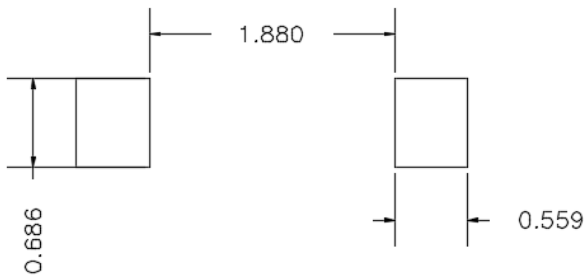

UNIT : mm

SUGGESTED SOLDER PAD LAYOUT



RB551V-40

Disclaimer

The information presented in this document is for reference only. Yangzhou Yangjie Electronic Technology Co., Ltd. reserves the right to make changes without notice for the specification of the products displayed herein to improve reliability, function or design or otherwise.

The product listed herein is designed to be used with ordinary electronic equipment or devices, and not designed to be used with equipment or devices which require high level of reliability and the malfunction of which would directly endanger human life (such as medical instruments, transportation equipment, aerospace machinery, nuclear-reactor controllers, fuel controllers and other safety devices), Yangjie or anyone on its behalf, assumes no responsibility or liability for any damages resulting from such improper use of sale.

This publication supersedes & replaces all information previously supplied. For additional information, please visit our website [http:// www.21yangjie.com](http://www.21yangjie.com) , or consult your nearest Yangjie's sales office for further assistance.